

Engenuity DST5417 Issue 3 2W/4W Data Station Termination with 309B-Type Equalization, Loopback and Jacks

CLEI* Code: DSTNV4Y3AA

| CONTENTS | PAGE# |
|-----------------------------------|-------|
| 1. GENERAL | 1 |
| 2. APPLICATIONS | 2 |
| 3. CIRCUIT/FUNCTIONAL DESCRIPTION | 2 |
| 4. OPTIONS & FEATURES | 4 |
| 5. INSTALLATION | 4 |
| 6. TESTING & TROUBLESHOOTING | 7 |
| 7. CUSTOMER & TECHNICAL SERVICES | 7 |
| 8. WARRANTY & REPAIRS | 7 |
| 9. SPECIFICATIONS | 8 |

1. GENERAL

1.1 Document Purpose

This document describes the Engenuity DST5417 Issue 3 L11 2W/4W Data Station Termination module, shown in Figure 1.

- NOTE -

Hereafter, the DST5417 Issue 3 L11 2W/4W Data Station Termination module may be referred to as the "DST5417" or "module."

1.2 Document Status

Whenever this practice is updated, the reason will be stated in this paragraph. This Practice, 001-01-000011 Rev. 001, replaces practice 030-101541 Rev. A, and practice 057-022001, and updates the company contact information.

1.3 Product Purpose and Description

The Engenuity Data Station Termination module, Model DST5417, is designed to provide an active interface between a 4-wire facility and a 2- or 4-wire data modem.

1.4 Product Mounting

The 200 MECHANICS[®] DST5417 module is typically mounted in 200, 400, or 550-type mounting assemblies which meet the pin-out plan of the module.

1.5 Product Features

The DST5417 offers the following features.

- 200 MECHANICS[®] high-density mounting capability
- Switch-selectable termination impedance of 150/600/1200 ohms for matching the unit to the impedance of the facility

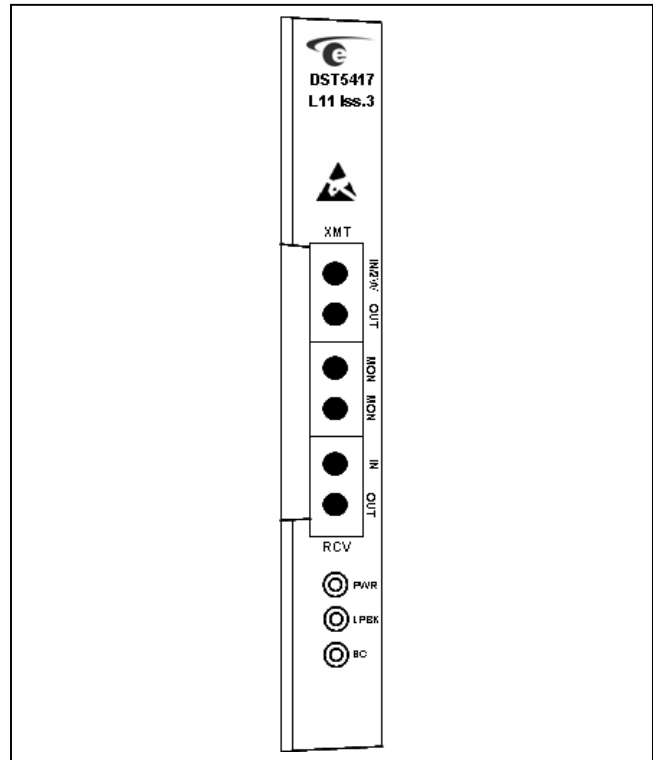

Figure 1. Front View of DST5417

- Switch-selectable 0dB or 24dB loss option in both transmission paths to establish the proper level adjustment capability for the RCV and XMT GAIN switches
- Prescription-selectable RCV and XMT GAIN adjustment for proper level coordination
- Receive path post-equalization adjustment (309B equivalent). Equalizer performance settings are in accordance with Bell System Practice (BSP) 332-912-222 specifications
- Optional, potentiometer-adjustable, pre-equalization in the transmit path (List 11 Option)
- Switch-selectable sealing current supply/term/off operation
- Manual or tone-activated loopback capability
- User selectable loopback frequencies

* CLEI is a registered trademark of Telcordia Technologies

200 MECHANICS[®] is registered trademark of Westell, Inc.

- Tone or switch-selectable automatic time-out release capability of loopback
- Equal-level loopback transmission capability via a switch-selectable 0dB, 8dB or 16dB level difference option
- Data modem disable leads (TEK5 & 6) are provided for disabling the data set during loopback for testing and maintenance purposes
- Front-panel bantam jacks provide monitor or direct access to the facility-side and direct access only to the modem-side
- Front-panel LEDs indicate the operational status of loopback, sealing current, and power
- Operational from a -22 to -56Vdc or 20 to 28Vac power source at a current rating of 75mA maximum
- 7-year warranty

2. APPLICATIONS

The DST5417 is used to interface a 4-wire facility with a 2- or 4-wire data modem and is normally located on the same premises as the data modem. Integral receive channel equalizers and impedance options on the facility side allow the module to be used with loaded, non-loaded, or carrier-derived facilities.

3. CIRCUIT/FUNCTIONAL DESCRIPTION

Refer to Figure 2, the DST5417 Functional/Block Diagram, as needed, while reading the following circuit description.

3.1 Receive Path

Signals received from the facility enter the DST5417 via the RCV IN port, pins 7 and 13 (RT and RR, respectively) and are applied to switch S2. S2 provides for the selection of the proper termination impedance of the unit (150/600/1200 ohms) to match the impedance of the facility.

The signal is then applied to switch S3 which permits the insertion (as required) of either 0 or 24dB of loss in the receive path. With S3 in the 0dB position, 0 to 24dB of gain is available for adjusting the receive path for proper level coordination via the RCV GAIN switches. With S3 in the 24dB position, 0 to 24dB of loss is available for adjusting the receive path for proper level coordination via the RCV GAIN switches. The signal is then applied to the FLAT/EQL switch.

The FLAT position is used if the EQUALIZER circuit is to be bypassed. When in the EQL position, the EQUALIZER circuit (309B equivalent) provides for equalizing cable response characteristics. Equalizer performance settings are in accordance with Bell System Practice (BSP) 332-912-222 specifications.

3.1.1 SLOPE

When interfacing non-loaded cable, the switch-section identified as NL must be placed in the NL (ON) position. When interfacing loaded cable, this switch-section must be in the OFF position. The remaining switch-sections, (labeled on the printed circuit board (PCB) as 1, 2, 4, and 8), are used to adjust the slope of the equalizer as required. Adjustment in slope response usually requires a compensating reduction in

receive gain adjustment. For plots of the different slope values, refer to Figures 3a and 3b.

3.1.2 HT (Height)

The HT switch-sections (labeled on PCB as 1, 2, 4, and 8) provide bump-type gain and are used to adjust the amplitude response at high-frequencies (approx. 2804 Hz) as required.

3.1.3 BW (Bandwidth)

The BW switch-sections (labeled on PCB as 1, 2, 4, and 8) are used to adjust the bandwidth of the amplitude response settings established with the HT switches. For plots of the different height values using bandwidth settings of 3 and 14, refer to the bottom two graphs in Figure 3. (Page 6) respectively.

Since the equalizer is an active device, there will be a 1 kHz gain for each of the receive equalizer settings. The 1 kHz gain for slope is shown in table form (in Figure 3) for both loaded (L) and non-loaded (NL) positions as well as the 1 kHz gain for each of the HT and BW settings. These gains are independent from each other and from the RCV GAIN settings. Thus, the 1 kHz gain of the entire receive amplifier is equal to the sum of the RCV GAIN, SLOPE, and HT and BW sections.

The RCV GAIN switch-sections, in conjunction with the loss switch (S3), provide from 24dB of loss to 24dB of gain in 0.1 dB increments for adjusting the receive path to the proper operating level. The output is then applied either to the RCV OUT port (pins 5 and 15) in 4-wire applications or through the HYBRID circuit and onto the XMT IN/2W port (pins 55 and 49) in 2-wire applications via option switch S6 (2W/4W).

3.2 Transmit Path

Signals from the 2- or 4-wire data modem enter the DST5417 via the XMT IN/2W port and are transformer-coupled to switch S6. In 2-wire applications, the signal is routed through the HYBRID which performs a 2-wire to 4-wire conversion and applies the resulting signal to the 0dB/ 24dB loss switch, S5. In 4-wire applications, the incoming signal is applied through S6 to S5.

Option switch S5 permits the insertion (as required) of either 0 or 24dB of loss in the transmit path. With S5 in the 0dB position, 0dB of loss to 24dB of gain is available for adjusting the transmit path to the proper operating level via the XMT GAIN switches. With S5 in the 24dB position, 24dB of loss to 0dB of gain is available for adjusting the transmit path to the proper operating level via the XMT GAIN switches.

The XMT GAIN circuit allows adjustment (from 24dB of loss to 24dB of gain) in 0.1 dB increments to be made to the transmit path to obtain the correct operating output level of the unit. In addition, the transmit path can be equipped with a potentiometer adjustable slope equalizer (List 11 Option) for use in pre-equalizing (from 0 to 6dB per octave) non-loaded cable if required.

The adjusted output is then transformer coupled to switch S2 which selects the proper source impedance (150/600/1200 ohms) and provides a balanced output at the XMT OUT port, pins 41 and 47 (TT and TR, respectively).

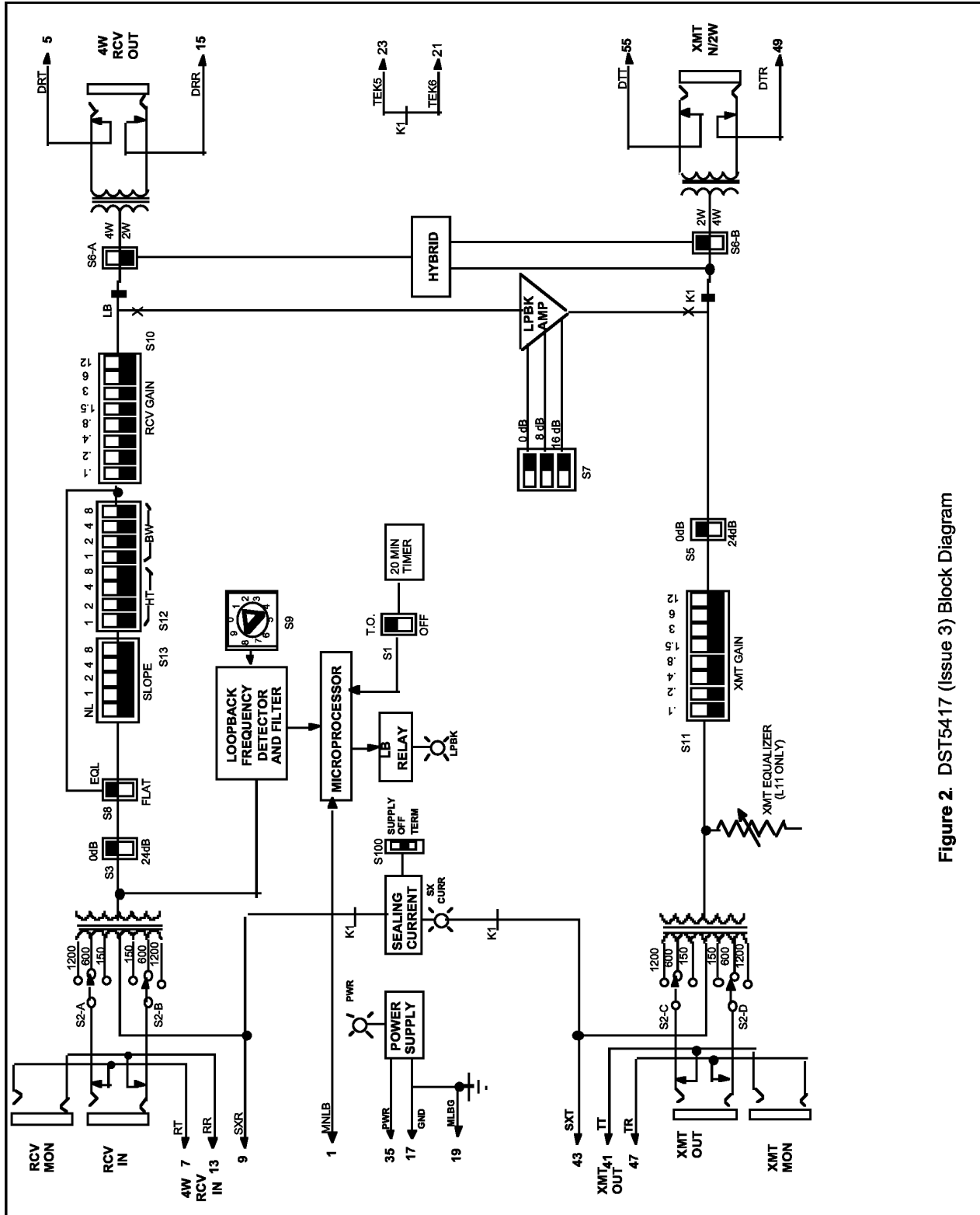

Figure 2. DST5417 (Issue 3) Block Diagram

3.3 Loopback

The loopback function makes possible remote testing of signal levels and facility frequency response. Data set disable leads (TEK5 and TEK6) are provided to disable the data set during loopback conditions. When activated the loopback circuitry isolates the data modem from the facility and interconnects the receive and transmit paths of the facility to permit testing of both the Data Station Termination and the facility to aid in identifying faulty equipment.

3.3.1 Tone -Activated Loopback

Switch S9 controls tone activated loopback functionality (See Figure 2). The loopback circuit activates upon detection of the selected tone sent from the facility and subsequent removal of that tone. When activated, loopback path gains of either 0,8, or 16dB (switch selectable) are provided for equal-level loopback transmission. Thus, for a RCV OUT level of -16dBm and a XMT IN level of 0dBm, the 16dB switch of option switch S7 is placed in the 16dB position. Likewise, for a RCV OUT level of -16dBm and a XMT IN level of -8dBm, the 8dB switch of option switch S7 is placed in the 8dB position. If the levels are the same, place the 0dB switch of S7 to the 0dB position. With switch S9 in either position 8 or 9, the loopback circuit is disabled from tone-activation but can still be activated manually.

3.3.2 Loopback Release

When the loopback circuit is tone-activated, loopback release is accomplished via the detection of the selected tone a second time or can be optioned to release automatically via option switch S1. When S1 is placed in the T.O. (time-out) position, the loopback circuit will automatically release 20 minutes after loopback initiation. This feature is provided to ensure restoration of the transmission paths in the event testing personnel fail to send the selected tone a second time, or if the tone is not detected. Switch S1 may also be optioned to the OFF position for applications requiring a longer loopback condition.

3.3.3 Manual Loopback Activation

The loopback circuitry can be activated manually by applying a ground to the MNLB lead, pin 1. During manually activated loopback, the 20 minute automatic time-out release feature will not affect the loopback condition and its release is dependent upon the removal of the ground.

3.4 Sealing Current

Sealing current is recommended on all metallic facilities to help prevent transmission path noise. Sealing current is a low value of dc current (approx. 20mA) applied to the 4-wire dry cable pairs on a simplex basis to break down resistance which may build up at non-soldered cable splices. Continuous application of sealing current helps prevent degradation of transmission performance.

The SEALING CURRENT circuit is controlled by option switch S100. When placed in the SUPPLY position, the DST5417 will supply 20mA of balanced, regulated current to the facility's simplex leads. The simplex leads at the distant end, however, must be connected together to complete the path. When sealing current is being supplied from the distant end, S100 can be placed in the TERM position to provide a 20mA

regulated load to the facility's simplex leads. With this switch in the OFF position, the SEALING CURRENT circuit is disabled, rendering the simplex leads available for external use.

- NOTE -

When supplying sealing current from the DST5417, a 24Vac or -24Vdc power option is adequate for a metallic facility loop of less than 1000 ohms. For loops in excess of 1000 ohms, a -48Vdc power source is recommended. The DST5417 may be remotely powered with -48Vdc from the serving CO via the cable facility and its associated simplex leads.

4. OPTIONS & FRONT PANEL FEATURES

The DST5417 contains features and switch options located on the front and side (PCB) panels that are used to condition the module for proper application and operation. See Figure 3 and Table 1 for the locations and descriptions of these options.

- NOTE -

Set any/all manual option switches prior to installing the unit.

5. INSTALLATION

Installation consists of inspecting the equipment for damages, following proper safety precautions, making any installer connections, setting any switch options (Table 1), mounting the module in the proper slot of the mounting assembly, and verifying the presence of power and signaling as indicated by the status LEDs.

- INSPECTION NOTE -

Visually inspect the product for damages prior to installation. If damaged in transit, immediately report the damage to the transportation company and to Engenuity.

- CAUTION -

Never apply power until all installer connections are made.



CAUTION - STATIC-SENSITIVE



This product contains static-sensitive components! Proper electrostatic discharge procedures must be followed to maintain personal and equipment safety. Do not store units near magnetic, electromagnetic or electrostatic fields. Always store or ship units in the original static-protective packaging from Engenuity. Use anti-static mats when working on units.



- CAUTION -



Hazardous voltages exist on telecommunication transport lines. Always use caution when wiring a live circuit or when performing maintenance testing. Unplugging the COT Line Unit from the COT shelf will remove the hazardous voltages from the line.

- PRECAUTIONARY STATEMENT -

**Never install telephone wiring during a lightning storm.
Never install telephone jacks in wet locations unless the jack is specifically designed for wet locations.
Never touch un-insulated telephone wires or terminals unless the telephone line has been disconnected at the network interface.
Use caution when installing or modifying telephone lines.**

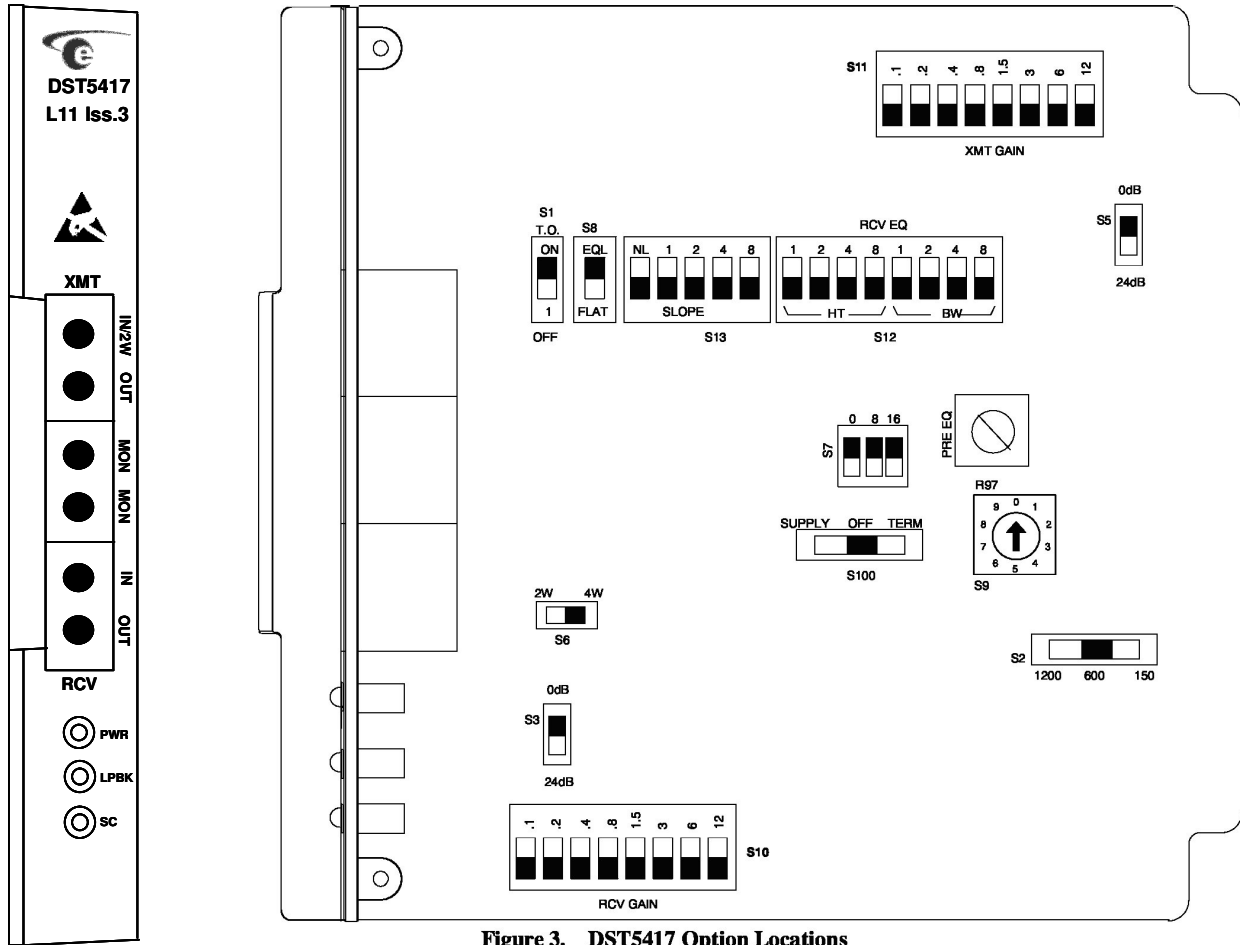

Figure 3. DST5417 Option Locations

| OPTION | POSITION | FUNCTION | |
|------------------------------------|---------------------------------|---|--|
| S1 | T.O. OFF | Provides automatic timeout-release of the loopback circuit after 20 minutes. Automatic time-release circuit disabled. | |
| S2 | 150 600 1200 | Selection used to terminate non-loaded cable facilities with more than 3dB loss. Selection used to terminate carrier-derived or non-loaded facilities with less than 3dB loss. Selection used to terminate long loaded cable facilities. | |
| S3(RCV) S5(XMT) | 0dB 24dB | Provides 0dB loss in the receive/transmit path. Provides 24dB loss in the receive/transmit path. After the loss range is selected, level adjustment is then accomplished via the RCV/XMT GAIN switches. | |
| S9 | 0 1--7 8,9 | Loopback circuit enabled via 2713Hz (default). Loopback circuit is enabled by 1713, 1913, 2313, 2413, 2513, 2813, 2913 Hz respectively. Loopback circuit disabled from tone activation. | |
| S6 | 2W 4W | For interfacing 2-wire equipment. For interfacing 4-wire equipment. | |
| S7 | 0dB/8dB/16dB | Provides for either a 0,8,or16dB difference in the receive and transmit data interface levels for equal-level loopback transmission. | |
| S100 | SUPPLY TERM OFF | Supplies 20mA of balanced, regulated sealing current to the facility's simplex leads. Provides 20mA regulated load to the facility's simplex leads when sealing current is supplied from the distant end. Sealing Current circuit disabled. | |
| RCV EQUALIZATION (S12 & S13) | SLOPE | N L 1,2,4,8 HT BW | When interfacing non-loaded cable, set this switch to the NL (ON) position. When interfacing loaded cable, set switch to OFF. Used to adjust the slope response of the equalizer. Used to adjust the height (amplitude) response at high-frequencies (approx.2804Hz). Used to adjust the bandwidth of the amplitude response settings of the HT controls. |
| | FLAT/EQL (S8) | FLAT EQL | By-passes equalizer circuit. Allows equalization adjustments to be made to both loaded and non-loaded cable. |
| | RCV (S10) AND XMT (S11) GAIN | 0.1,0.2,0.4,0.8, 1.5, 3, 6, and 12dB | Provides 0 to 24dB adjustment in 0.1 dB steps that set the receive and transmit paths to the correct operating levels. Adjust accordingly with respect to S3 and S5 option switches settings (ON is towards the value silk-screened on the PCB). |

Table 1. DST5417 Switch Options

| Shape Number | Switch Number | | | | Slope Setting | 1kHz GAIN | | HT SETTING | | | | | | | | | | | | | | | | |
|--------------|---------------|-----|-----|-----|---------------|-----------|-------|------------|---|-----|-----|-----|-----|-----|-----|-----|-----|-----|-----|-----|-----|-----|-----|-----|
| | 1 | 2 | 4 | 8 | | NL | L | 0 | 1 | 2 | 3 | 4 | 5 | 6 | 7 | 8 | 9 | 10 | 11 | 12 | 13 | 14 | 15 | |
| 0 | off | off | off | off | 0 | 0.0dB | 0.0dB | 0 | 0 | 0 | 0 | 0 | 0 | 0 | 0 | 0 | 0 | 0 | 0 | 0 | 0 | 0 | 0 | |
| 1 | on | off | off | off | 1 | 0.4 | 1.4 | 1 | 0 | 0 | 0 | 0 | 0 | 0 | 0 | 0 | 0 | 0 | 0 | 0 | 0 | 0 | 0 | |
| 2 | off | on | off | off | 2 | 0.9 | 2.6 | 2 | 0 | 0 | 0 | 0 | 0 | 0 | 0 | 0 | 0 | 0 | 0 | 0 | 0 | 0 | 0 | |
| 3 | on | on | off | off | 3 | 1.4 | 3.7 | 3 | 0 | 0 | 0 | 0 | 0 | 0 | 0 | 0 | 0 | 0 | 0 | 0 | 0 | 0 | 0.1 | |
| 4 | off | off | on | off | 4 | 1.8 | 4.7 | 4 | 0 | 0 | 0 | 0 | 0 | 0 | 0 | 0 | 0 | 0 | 0 | 0 | 0 | 0 | 0.1 | |
| 5 | on | off | on | off | 5 | 2.3 | 5.5 | 5 | 0 | 0 | 0 | 0 | 0 | 0 | 0 | 0 | 0 | 0 | 0 | 0 | 0.1 | 0.1 | 0.1 | |
| 6 | off | on | on | off | 6 | 2.8 | 6.3 | 6 | 0 | 0 | 0 | 0 | 0 | 0 | 0 | 0 | 0.1 | 0.1 | 0.1 | 0.1 | 0.1 | 0.1 | 0.2 | |
| 7 | on | on | on | off | 7 | 3.4 | 7.2 | 7 | 0 | 0 | 0 | 0 | 0 | 0.1 | 0.1 | 0.1 | 0.1 | 0.1 | 0.1 | 0.1 | 0.2 | 0.2 | 0.3 | |
| 8 | off | off | off | on | 8 | 3.7 | 7.8 | 8 | 0 | 0 | 0 | 0 | 0.1 | 0.1 | 0.1 | 0.1 | 0.2 | 0.2 | 0.2 | 0.3 | 0.3 | 0.4 | 0.4 | |
| 9 | on | off | off | on | 9 | 4.2 | 8.4 | 9 | 0 | 0 | 0 | 0.1 | 0.1 | 0.1 | 0.1 | 0.2 | 0.2 | 0.2 | 0.3 | 0.3 | 0.4 | 0.5 | 0.7 | |
| 10 | off | on | off | on | 10 | 4.6 | 9.0 | 10 | 0 | 0 | 0 | 0.1 | 0.1 | 0.1 | 0.2 | 0.2 | 0.2 | 0.3 | 0.3 | 0.4 | 0.5 | 0.7 | 0.9 | |
| 11 | on | on | off | on | 11 | 5.0 | 9.5 | 11 | 0 | 0 | 0 | 0.1 | 0.1 | 0.2 | 0.2 | 0.3 | 0.3 | 0.4 | 0.4 | 0.5 | 0.7 | 0.9 | 1.2 | |
| 12 | off | off | on | on | 12 | 5.4 | 10.0 | 12 | 0 | 0 | 0.1 | 0.1 | 0.1 | 0.2 | 0.2 | 0.3 | 0.4 | 0.5 | 0.6 | 0.8 | 0.9 | 1.2 | 1.7 | |
| 13 | on | off | on | on | 13 | 5.8 | 10.5 | 13 | 0 | 0.1 | 0.1 | 0.1 | 0.2 | 0.2 | 0.3 | 0.4 | 0.5 | 0.6 | 0.7 | 0.9 | 1.1 | 1.3 | 1.7 | |
| 14 | off | on | on | on | 14 | 6.2 | 11.0 | 14 | 0 | 0.1 | 0.1 | 0.2 | 0.3 | 0.4 | 0.5 | 0.7 | 0.8 | 1.0 | 1.2 | 1.4 | 1.7 | 2.0 | 2.5 | |
| 15 | on | on | on | on | 15 | 6.6 | 11.4 | 15 | 0 | 0.1 | 0.2 | 0.3 | 0.4 | 0.5 | 0.7 | 0.9 | 1.2 | 1.5 | 1.7 | 2.0 | 2.4 | 2.8 | 3.3 | 3.9 |

SHAPE NUMBERS FROM SWITCHES LABELED 1, 2, 4, 8

NL=NONLOADED
L= LOADED
1 kHz GAIN in dB VS SLOPE SETTINGS

1 kHz GAIN in dB for HT and BW SETTINGS
HT setting of 0 disables the Bump Unit for all BW settings

RELATIVE RESPONSE OF SLOPE SETTING

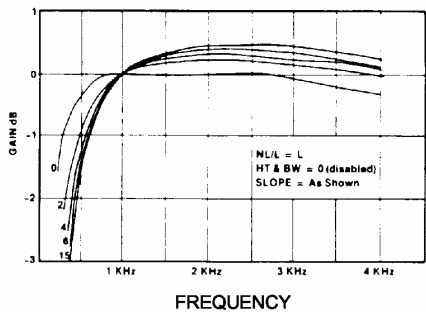
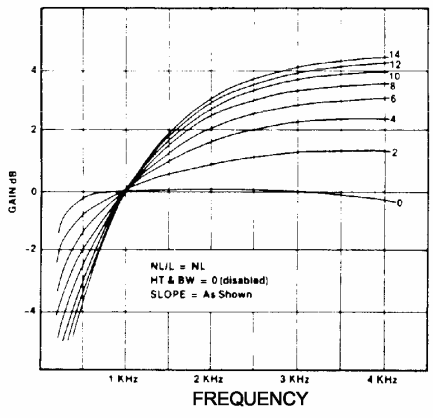

RELATIVE RESPONSE OF THE HIGH FREQUENCY EQUALIZATION

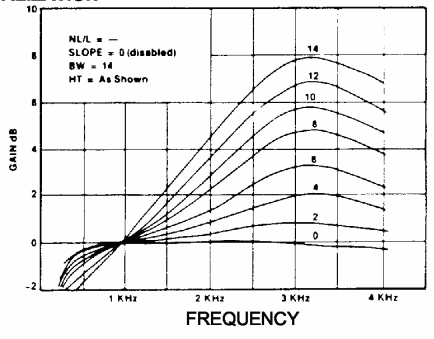
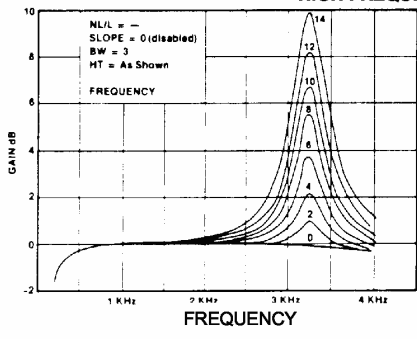

Figure 4. Cable Adjustment Settings

5.1 Making Installer Connections

Installer connections to the unit are made by wire-wrapping leads onto the pins of the appropriate 56-pin connector of the unwired Type 550 mounting assembly (Type 400 equiv.). If installing unit into Westell's USA Mounting, connections are made via 25-pair cables mating to the appropriate 25-pair connectors located on the rear of the assembly. Pin identifications for proper wiring are listed in Table 2. Power requirement is -22 to -56Vdc or from a 20 to 28Vac power source at a current rating of 75mA maximum.

Table 2. Installer Connections

| DESCRIPTION | | PIN |
|---------------------------|----------|-----|
| RT – RCV IN Tip | | 7 |
| RR – RCV IN Ring | | 13 |
| TT – XMT OUT Tip | FACILITY | 41 |
| TR – XMT OUT Ring | | 47 |
| SXR – Simplex RCV | | 9 |
| SXT – Simplex XMT | | 43 |
| | | |
| DRT – Data RCV OUT Tip | | 5 |
| DRR – Data RCV OUT Ring | | 15 |
| DTT – Data XMT IN/2W Tip | MODEM | 55 |
| DTR – Data XMT IN/2W Ring | | 49 |
| TEK5 – Data Modem | | 23 |
| TEK6 – Disable Leads | | 21 |
| | | |
| MNLB – Manual Loopback | | 1 |
| MLBG – Manual LPBK Ground | MISC | 19 |
| PWR – Power INPUT | | 35 |
| GND – Ground | | 17 |

5.2 Mounting the Module

After completing the wiring and before installing the module, condition or set the appropriate option switches (Table 1) to their desired position(s) by placing them in their required position as specified on the Circuit Layout Record (CLR) card. The 200 MECHANICS® DST5417 module is typically mounted in 200, 400, or 550-type mounting assemblies which meet the pin-out plan of the module. Align the module with the mounting or assembly card guides above and below the unit and insert as far as it will go into the slot connector.

- CAUTION -

Use care when installing and removing modules - do not force a module into place. If a module resists insertion, remove it and check for obstructions in or near the connectors and mounting slots. The module may then be carefully aligned and gently re-inserted.

6. TESTING, ALIGNMENT & TROUBLESHOOTING

The Testing and Alignment procedures shown in Table 3 may be performed after the unit is installed and power applied. Test equipment required to perform these procedures is as follows:

- A. Transmission Measuring Set (TMS), HALCYON 704A2 Wide Band Test Set, HEWLETT PACKARD 3551 Transmission Test Set, or equivalent
- B. Variable Frequency Oscillator (VFO), if not contained within the TMS
- C. Bantam to 310 cords

6.1 Field Repairs

This equipment should not be field repaired. If the equipment is suspected of being faulty, replace it with another unit, optioned identically, and retest. If the replacement unit appears to operate correctly, the original unit may be faulty and should be returned to Engenuity for repair or replacement (Paragraph 8.2).

6.2 Troubleshooting

The procedures outlined in this practice are intended only to ascertain proper operation of the unit and to isolate problems to the most probable area. If trouble is encountered, verify all installer connections to the assembly and check that the CO power fuse is not blown. Also verify all module connections, option switch settings, and alignment adjustments, and verify the modules are making a positive connection with the shelf connector. If trouble persists, replace the suspect unit and repeat procedures outlined. These procedures are not designed to effect repairs or modifications. Any tests beyond those outlined herein, or repairs made beyond replacing a faulty unit, are not recommended and may void the warranty.

7. CUSTOMER & TECHNICAL SERVICES

If technical or customer assistance is required, contact Engenuity by calling one of the following numbers:

Voice: (630) 444-0778 or

Voice: (800) 980-3266

Visit Engenuity at www.engenuitycom.com for additional information about Engenuity.

8. WARRANTY & REPAIRS

8.1 Warranty

Engenuity warrants this product to be free of defects at the time of shipment. Engenuity also warrants this product to be fully functional for the time period specified by the terms and conditions governing the sale of the product. Any attempt to repair or modify the equipment by anyone other than an authorized Engenuity representative will void the warranty.

8.2 Repair and Return

Engenuity will repair or replace any defective Engenuity equipment without cost during the warranty period if the unit is defective for any reason other than abuse, improper use, or improper installation. Before returning the defective equipment, first request a Return Material Authorization (RMA) number from Engenuity. Once an RMA number is obtained, return the defective unit, freight prepaid, along with a brief problem description, to:

Engenuity Communications, Inc.
3545 Stern Avenue
St. Charles, IL 60174

Replacements will be shipped in the fastest manner consistent with the urgency of the situation. Engenuity will continue to repair or replace faulty equipment beyond the warranty period for a nominal charge. Contact Engenuity for details.

Table 3. Alignment Procedures

| STEP | ACTION | | | | | | | | |
|--|---|--|---|------------------------------|------------------------------|----------------------------------|-------------------------------|--------------------------------|----------------------------------|
| 1. | <p>Set all option switches to position as specified on CLR card. If cable being interfaced is non-loaded, place option switch NL in the NL (ON) position. For loaded cable, option this switch to OFF. If equalization is not required, option the FLAT/EQL switch to FLAT and proceed to Step 2 then Step 4. If equalization is required, option this switch to EQL and initially set the HT, BW, and SLOPE switches as follows:</p> <table border="1"> <thead> <tr> <th>Non-loaded Cable Switch-section NL = ON</th> <th>Loaded Cable Switch-section NL = OFF</th> </tr> </thead> <tbody> <tr> <td>SLOPE = 0 (1,2,4, and 8 OFF)</td> <td>SLOPE = 0 (1,2,4, and 8 OFF)</td> </tr> <tr> <td>HT = 3 (1 and 2 ON; 4 and 8 OFF)</td> <td>HT = 2 (2 ON; 1,4, and 8 OFF)</td> </tr> <tr> <td>BW = 14 (2,4, and 8 ON; 1 OFF)</td> <td>BW = 6 (2 and 4 ON; 1 and 8 OFF)</td> </tr> </tbody> </table> | Non-loaded Cable Switch-section NL = ON | Loaded Cable Switch-section NL = OFF | SLOPE = 0 (1,2,4, and 8 OFF) | SLOPE = 0 (1,2,4, and 8 OFF) | HT = 3 (1 and 2 ON; 4 and 8 OFF) | HT = 2 (2 ON; 1,4, and 8 OFF) | BW = 14 (2,4, and 8 ON; 1 OFF) | BW = 6 (2 and 4 ON; 1 and 8 OFF) |
| Non-loaded Cable Switch-section NL = ON | Loaded Cable Switch-section NL = OFF | | | | | | | | |
| SLOPE = 0 (1,2,4, and 8 OFF) | SLOPE = 0 (1,2,4, and 8 OFF) | | | | | | | | |
| HT = 3 (1 and 2 ON; 4 and 8 OFF) | HT = 2 (2 ON; 1,4, and 8 OFF) | | | | | | | | |
| BW = 14 (2,4, and 8 ON; 1 OFF) | BW = 6 (2 and 4 ON; 1 and 8 OFF) | | | | | | | | |
| 2. | Receive Alignment - Insert a properly terminated TMS into the RCV OUT jack (4W applications) or into the XMT IN/2W jack (2W applications). Have Serving Test Center (STC) send a 1004Hz test tone at -13dBm O. Adjust the RCV GAIN switch-sections until TMS indicates a level of -16dBm or as specified on the CLR. | | | | | | | | |
| 3. | Equalization - Request the STC to transmit a 2804Hz test tone and adjust the HT switches until the TMS indicates the level specified on the CLR. (Note: It may be necessary to repeat Steps 2 and 3 in order to obtain the proper level at both 1004 and 2804Hz). If the level cannot be obtained easily, use the SLOPE switches and repeat the Equalization procedure until the -16dBm level (or as specified on the CLR) is obtained at both frequencies using the SL, HT, and RCV GAIN switch settings. | | | | | | | | |
| 4. | Transmit Alignment - Insert an oscillator, adjusted for 1004Hz at 0 dBm, into the XMT IN/2W jack and a properly-terminated TMS into the XMT OUT jack. Adjust the XMT GAIN switches until the level <u>specified on the CLR is obtained (typically -8dBm).</u> | | | | | | | | |
| 5. | Transmit Equalization (Optional) - Have distant end measure and record levels received at oscillator frequencies of 1004Hz and 3004Hz. If the level at 3004Hz is unacceptable, re-send the 1004Hz level and adjust the XMT EQL control until the level is the same at both frequencies. This procedure may have to be repeated and rechecked at both frequencies in order to obtain the same level. Then, readjust the XMT GAIN switches until the specified level (typically -8 dBm) is indicated on the TMS as described in Step 4. | | | | | | | | |

9. SPECIFICATIONS

To order units, call the telephone number shown in Part 7 and please specify the part number shown in Table 4.

| Model # | Part # | Description |
|---------|-----------|--|
| DST5417 | 5417I3L11 | 2W/4W Data Station Termination Module, with 309B-type equalization, Loopback, and jacks, and also with List 11 Option that adds dial adjustable transmit pre-Equalization. CLEI* Code: DSTNV4Y3AA. |

*CLEI is a trademark of Telcordia Technologies.

Table 4. Ordering and Option Information

The electrical and signaling specifications are listed below, and the physical specifications are shown in Table 5.

- A. **Receive Gain:** Provides from 0 to 24dB of loss or gain in 0.1 dB increments for setting the receive path level. The LOSS or GAIN range is determined by option switch S3.
- B. **Transmit Gain:** Provides from 0 to 24dB of loss or gain in 0.1 dB increments for setting the transmit path level. The LOSS or GAIN range is determined by option switch S5.
- C. **Impedance: Facility,** switch-selectable for 150, 600, or 1200 ohms; equipment (4-wire or 2-wire), 600 ohms, fixed.
- D. **Max. Output:** +7dBm.
- E. **Test Jacks:** Bantam type. Facility, monitor and module access; Equipment, module access only.
- F. **RCV Equalizer:** Amplitude equalization may be added using the height (HT), bandwidth (BW), and slope (SL) switches. Performance settings (309B equivalent) are in accordance with BSP 332-912-222 specifications.
- G. **RCV Equalizer Gain:** 0 to 15.3dB at 1 kHz, depending on equalizer settings.
- H. **XMT Equalizer (Optional):** Provides from 0 to 6dB per octave of slope-type equalization on non-loaded cable (pot-adjustable)

I. RCV Equalizer Range:

| | H88 loaded cable | Non-loaded cable |
|------|------------------|------------------|
| 19ga | <192kft | <66kft |
| 22ga | <102kft | <48kft |
| 24ga | <66kft | <38kft |
| 26ga | <48kft | <29kft |

Loopback

J. Frequency: 1713, 1913, 2313, 2413, 2513, 2813 2913 and 2713Hz, (selectable) ±7Hz must operate; ±37Hz must not operate. Circuit may be disabled from tone activation via S9.

K. Detection Time: 1.4 sec. operate; 0.7 sec. release; nominal.

L. Level: -24dBm (typically -30dBm) to -3dBm.

M. Time-out Option: 20 minutes +5% (may be switch-disabled).

N. Transmission Level: Equal-level +1dB (measured at facility ports) for 16dB, 0dB, or 8dB differences between receive and transmit data interface levels (switch-selectable).

O. Power: -22 to -56Vdc or 20 to 28Vac, 35mA idle, 75mA maximum.

| Physical Feature | U.S. | Metric |
|------------------|--|------------|
| Height | 5.6 inches | 14.2 cm |
| Width | 0.7 inches | 1.8 cm |
| Depth | 5.9 inches | 15 cm |
| Weight (approx.) | 12 ounces | 340 g |
| Operating Temp. | 32° to 122°F | 0° to 50°C |
| Humidity | 0 to 95% (non-condensing) | |
| Mounting | One position of a Type 550 shelf (Type-400 equivalent) or a 200 MECHANICS shelf. | |

Table 5. Physical Specifications